

CG90IANT9

Categorie fornuis	90x60 cm
Aantal ovens met energielabel	1
Cavity heat source	Elektrisch
Type kookplaat	Inductie
Type primaire oven	Thermogeventileerd
Reinigingssysteem primaire oven	Vapor Clean
EAN-code	8017709288716
Energie-efficiëntieklasse	A



Esthetiek

Esthetiek	Classici	Display	Touch
Series	Concerto	Aantal bedieningsknoppen	2
Kleur	Antraciet	Kleur serigrafie	Zilver
Afwerking	Mat	Handgreep	Smeg Tondino
Design	Standaard	Kleur handgreep	Geborsteld roestvrijstaal
Deur	Geheel glas	Type glas	Zwart
Kleur kookplaat	RVS	Pootjes	Zwart
Afwerking bedieningspaneel	Gekleurd plaatstaal	Logo	Geassembleerd
Bedieningsknoppen	Smeg Classici	Positie logo	Strook onder de oven
Kleur knoppen	RVS		

Programma's / functies

Aantal kookfuncties 6

Traditionele kookfuncties



Statisch



Geventileerd



Turbo



ECO



Grote vlak-grill



Fan assisted bottom

Schoonmaak functie



Vapor Clean

Opties kookplaat

		Kinderbeveiliging	Ja	ECO-Logic optie - stappen	3000, 4500, 7400 W
		ECO-Logic optie	Ja		

Technische specificaties kookplaat



Totaal aantal kookzones 4

Linksvoor - Inductie - enkel - 2.30 kW - Booster 3.00 kW - Ø 21.0 cm

Linksachter - Inductie - enkel - 1.30 kW - Booster 1.40 kW - Ø 18.0 cm

Rechtsachter - Inductie - maxi - 2.30 kW - Booster 3.00 kW - Ø 21.0 cm

Rechtsvoor - Inductie - enkel - 1.30 kW - Booster 1.40 kW - Ø 18.0 cm

Aantal kookzones met booster	4	Indicator minimaal te gebruiken diameter	Ja
Automatische stop bij oververhitting	Ja	Indicator geselecteerde zone	Ja
Automatische aanpassing panafmeting	Ja		

Technische specificaties primaire oven



Aantal lampen	1	Uitneembaar glas binnendeur	Ja
Aantal ventilatoren	1	Aantal ruiten ovendeur	3
Netto inhoud	115 l	Aantal thermo-reflecterende ruiten	1
Bruto inhoud 1e oven	129 l	Veiligheidsthermostaat	Ja
Materiaal ovenruimte	Ever Clean emaille	Koelsysteem	Mantelkoeling
Aantal kookniveaus	5	Afmetingen bruikbare interne ovenruimte (hxbxd)	371x724x418 mm
Type ovenrekken	Metalen zijsteunen	Temperatuurregeling	Elektro-mechanisch
Soort verlichting	Halogeen	Onderwarmte - vermogen	1700 W
Vermogen lamp	40 W	Bovenwarmte - vermogen	1200 W
Instelling kooktijd	Start en stop	Grill - vermogen	1700 W
Automatische inschakeling verlichting bij openen deur	Ja	Grote vlakgrill - vermogen	2900 W
Deur openen	naar beneden	Circulatie - vermogen	2000 W
Uitneembare ovendeur	Ja	Type grill	Elektrisch
Volledig glazen binnendeur	Ja		

Opties primaire oven

Timer	Ja	Minimum temperatuur	50 °C
-------	----	---------------------	-------

Akoestisch signaal
einde kooktijd

Ja

Maximum temperatuur 260 °C

Meegeleverde accessoires primaire oven en kookplaat

Rek met achter- en
zijstop 1
Bakplaat (40 mm) 1

Inzetrooster 1

Elektrische aansluiting

Aansluitwaarde 10600 W
Stroom 46 A
Spanning 220-240 V
Spanning 2 (V) 380-415 V

Type of electric cable
installed Yes, Single phase
Type stroomkabel Yes, Double and Three
Phase
Frequentie 50/60 Hz
Aansluitkast 5 polig

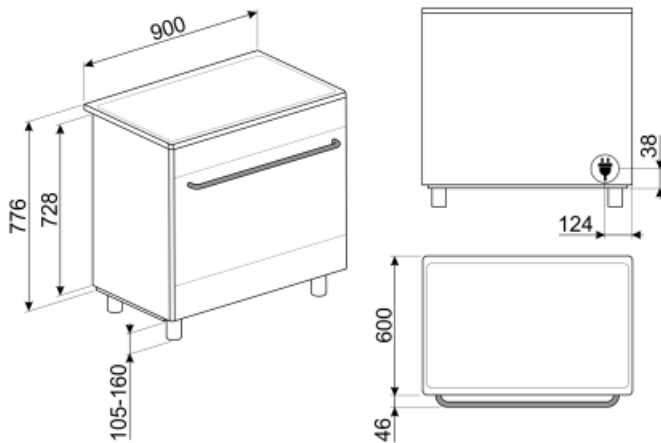

Accessoires niet inbegrepen

AIRFRY9

Air fryer rack AIRFRY . Ideal for recreating traditional frying in the oven, but with fewer calories and less fat. It allows you to cook quickly and simply dishes such as French fries, fried vegetables and fish, ensuring perfect browning and crispiness.



GTP

Gedeeltelijk uittrekbare telescopische geleiders (1 niveau)



PPR9

Refractory pizza stone without handles. Squared shaped stone: L64xH2,3xP37,5 cm Suitable also for gas ovens, to be put on the griddle.



BBQ9



KIT90X9-1

Splashback, stainless steel, 90cm, for Concerto cookers with single MF or gas oven

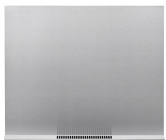

KITPDQ

Height reduction feet (850mm), stainless steel, for Concerto cookers (850-881mm)



PALPZ

Pizzaschep met inklapbare handgreep breedte: 315 mm lengte: 325 mm



SFLK1

Kinderslot



PRTX

Ronde pizzasteen met handvaten, diameter 35 cm



KIT600SNL-9

Cover strip for hob back side, depth 60mm, suitable for 90cm single oven Concerto cookers



KIT90N9

Splashback black , 90 cm, suitable for BU & BM cookers



KITH95

Hoogte uitbreidingsset (min.13cm - max.19,5cm), roestvrij staal



SCRP

Inductie- en keramische kookplaten en teppanyaki-schraper



GTT

Volledig uittrekbare telescopische geleiders (1 niveau)



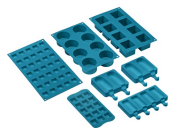



















SMOLD

Set van 7 siliconen vormpjes voor ijsjes, ijslolly's, pralines, ijsblokjes of om etenswaren te portioneren. Bruikbaar van -60 ° C tot + 230 ° C

Symbols glossary (TT)

 <p>Powerbooster: optie zorgt ervoor dat de zone op vol vermogen werkt wanneer zeer intensief koken nodig is.</p>	 <p>Kinderslot: sommige modellen zijn voorzien van een apparaat om het programma / de cyclus te vergrendelen zodat het niet kan per ongeluk veranderd</p>
 <p>A: Droogprestaties van het product, gemeten vanaf A +++ tot D / G afhankelijk van de productfamilie</p>	 <p>Luchtkoelsysteem: om een veilig oppervlak te garanderen temperaturen.</p>
 <p>Deuren met driedubbele beglazing: aantal glazen deuren.</p>	 <p>ECO-logic: optie stelt u in staat om de vermogenslimiet van de werkelijke energiebesparing van het apparaat te beperken</p>
 <p>Geëmailleerde binnenkant: De geëmailleerde binnenkant van alle Smeg-ovens heeft een speciale antacidumvoering die helpt om de binnenkant schoon te houden door de hoeveelheid kookvet te verminderen.</p>	 <p>Fan assisted base: the mix of fan and lower heating element alone allows to finish cooking foods already cooked on the surface but not internally more quickly. This system is recommended to finish cooking foods that are already well cooked on the surface, but not internally, which therefore require a moderate higher heat. Ideal for any type of food.</p>
 <p>Ventilator met bovenste en onderste elementen: de elementen in combinatie met de ventilator zijn bedoeld om een meer gelijkmatige warmte te bieden, een methode die vergelijkbaar is met conventioneel koken, dus voorverwarmen is vereist. Het meest geschikt voor items die langzaam koken vereisen.</p>	 <p>De ovenruimte wordt tegelijk door het onder- en bovenelement verwarmt. De hitteverdeling over het gerecht is afhankelijk van het niveau waarop men dit plaatst. Geschikt voor bakken op 1 niveau. Gerechten: alle ovenschotels, vlees, gevogelte, brood, (gevulde) taarten. Speciaal: gans en eend (bevatten veel vet).</p>
 <p>ECO: low energy consumption cooking: this function is particularly suitable for cooking on a single shelf with low energy consumption. It is recommended for all types of food except those that can generate a lot of moisture (for example vegetables). To achieve maximum energy savings and reduce time, it is recommended to put the food in the oven without preheating the cooking compartment</p>	 <p>De warmte wordt geproduceerd door het grill- en bovenelement. Verhitting over het volledige oppervlak. De thermostaat wordt, afhankelijk van het gerecht, in de regel op de maximale stand gezet. Bij een korte baktijd kan de ovendeur gesloten blijven; bij langere baktijd blijft deze gedeeltelijk geopend. Voor vleesgerechten (klein- en middelgroot), vleespennen, vis, groenten, gratineren etc.</p>
 <p>Turbo: the heat comes from 3 directions: above, below and from the back of the oven The fan is active. It allows quick cooking, even on several shelves without mixing the aromas. Ideal for large volumes or foods that require intense cooking.</p>	 <p>Giant zone: The giant zone offers extra space and flexibility.</p>
 <p>Overheat protection: The safety system that automatically turns off the hob in case of overheating of the control unit.</p>	 <p>Induction: The work of these hobs is based on the principle of electromagnetic induction. The heat is generated directly in the bottom of the pan during its contact with the hob.</p>
 <p>All glass inner door: All glass inner door, a single flat surface which is simple to keep clean.</p>	 <p>The inner door glass: can be removed with a few quick movements for cleaning.</p>



verlichting



The oven cavity has 5 different cooking levels.



Vapor Clean: a simple cleaning function using steam to loosen deposits in the oven cavity.



The capacity indicates the amount of usable space in the oven cavity in litres.