

HOBD182DG

Familie	Kookplaat
Inbouw	Vlak opbouw of vlak inbouw
Afmeting	80 cm
Voeding	Elektrisch
Type	Inductie met geïntegreerde afzuiging
Filtering	Expulsie
Elektronische bediening	Ja
EAN-code	8017709331856
Energie efficiëntieklasse (EEC)	A++



Esthetiek



Esthetiek	Linea
Kleur	Neptune Grey
Afwerking	Glas
Materiaal	Glas
Type glas	Keramisch
Glazen rand	Rechte rand
Pannendragers	Gietijzer
Type bediening	EVO Slider
Slider	Ja
Slider	Wit
Positie bediening	Voor
Kleur serigrafie	Grijs

Programma's / functies

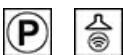

Totaal aantal kookzones	4
Aantal inductiekookzones	4
Opties tijdprogrammering	Automatische uitschakeling
Aantal kookzones met booster	4
Aantal Multizones	2
Hoofdtoets aan/uit	Ja
Vermogenniveaus	9
Auto-vent 2.0	Ja

Opties



Multizone optie	Ja	Resttijd indicator	Ja
Flexible Zone Type	MultiZone	ECO-Logic optie	Ja, Advance
Worktop Cut-Out	482-483x765-766 mm	ECO-Logic optie - stappen	2800, 3500, 4500, 7400 W
Warmhoudfunctie	Ja	Showroom demo optie	Ja
Automatische uitschakeling	4	Kinderbeveiliging	Ja
Pauze optie	Ja	Optie Toetsblokkering t.b.v. reiniging	Ja
Timer	1	Quick start	Ja
Akoestisch signaal einde kooktijd	Ja	Snelle selectie niveaus	Ja

Technische specificaties



Linksvoor - Inductie - Multizone - 2.10 kW - Booster 3.00 kW - 21.0x19.0 cm
Linksachter - Inductie - Multizone - 2.10 kW - Booster 3.00 kW - 21.0x19.0 cm
Rechtsachter - 2.10 kW - Booster 3.00 kW - 21.0x19.0 cm
Rechtsvoor - 2.10 kW - Booster 3.00 kW - 21.0x19.0 cm
Multizone left - Booster 3.70 kW - 39.0x21.0 cm
Multizone right - Booster 3.70 kW - 39.0x21.0 cm

Automatische herkenning panafmeting	Ja	Automatisch uitschakelen i.g.v. overkoken	Ja
Automatische panherkenning	Ja	Restwarmte indicator	Ja
Permanente automatische pandetectie met indicatie van de relatieve controle	Ja	beveiliging tegen onbedoeld inschakeling	Ja

Meegeleverde accessoires

Meegeleverde accessoires	Afzuig- en filter set inclusief buizen en koolstoffilter
--------------------------	--

Elektrische aansluiting

Aansluitwaarde	7620 W	Type stroomkabel	Universeel
Stroom	33 A	Frequentie	50/60 Hz
Spanning (V)	220-240 V	Lengte voedingskabel	120 cm
Spanning 2 (V)	380-415 V	Connection box	6 polig

Controls (hood)

Bediening afzuigkap	Touch control	Display	Ja
Kleur LED	Wit		

Programs / Functions (hood)

Aantal snelheden	8	Tijdstellingen	Delay
Snelheid Intensief	2	Overige opties	Kit for Recirculation and Extraction included
Overige functies	AUTOVENT		

Technical Features (Hood)

Capaciteit P0	750 m ³ /h	Vetfilters	Roestvrijstaal
Vermogen motor	220 W	Meegeleverde koolstoffilters	YES, regenerable
Aantal filters	1	Indicator vervangen filter	Ja

Prestatie / Energielabel (afzuigkap)

Hydrodynamische efficiëntie (FDEC)	37,60	Akoestische A-gewogen geluidsemisatie op maximum snelheid	65 dB(A)
Hydrodynamische-efficiëntieklasse (FDEC)	A	Akoestische A-gewogen geluidsvermogen in de lucht met intensieve snelheid	72 dB(A)
Lichtefficiëntie (LEC)	0,0 lux/W	Vermogensverbruik in Off modus (Po)	0,49 W
Lichtefficiëntieklasse (LEC):	NA	Tijdstoenamefactor (F)	0,6
Vetfilterefficiëntie (GFE)	85,1 %	Energie-efficiëntie-index	32,8
Vetfilterefficiëntieklasse (GFEC)	B	Gemeten luchtstroom op beste-efficiëntiepunt (Qbep)	328 m ³ /h
Luchtstroom op de minimumsnelheid (Qmin)	245 m ³ /h	Gemeten luchtdruk op beste-efficiëntiepunt (Qbep)	540 Pa
Luchtstroom op de maximumsnelheid (Qmax)	505 m ³ /h	Gemeten opgenomen vermogen op beste-efficiëntiepunt (Wbep)	131 W
Luchtstroom op de boostersnelheid (Qboost)	700 m ³ /h	Geluidsniveau op de hoogste stand (Lwa)	65 dB(A)
Akoestische geluidsdruk op minimum snelheid (SPEmin)	51 dB(A)		

Snelheid 1

Capaciteit (IEC 61591)	245 m ³ /h
Geluidsniveau (IEC 60704-2-13)	51 dB(A)
Druk	290 Pa
Vermogen	35 W

Snelheid 2

Capaciteit (IEC 61591)	285 m ³ /h
Geluidsniveau (IEC 60704-2-13)	55 dB(A)
Druk	370 Pa
Vermogen	45 W

Snelheid 3

Capaciteit (IEC 61591)	350 m ³ /h
Geluidsniveau (IEC 60704-2-13)	57 dB(A)
Druk	525 Pa
Vermogen	65 W

Snelheid 4

Capaciteit (IEC 61591)	380 m ³ /h
Geluidsniveau (IEC 60704-2-13)	59 dB(A)
Druk	530 Pa
Vermogen	75 W

Snelheid 5

Capaciteit (IEC 61591)	410 m ³ /h
Geluidsniveau (IEC 60704-2-13)	62 dB(A)
Druk	535 Pa
Vermogen	85 W

Snelheid 6

Capaciteit (IEC 61591)	445 m ³ /h
Geluidsniveau (IEC 60704-2-13)	63 dB(A)
Druk	540 Pa
Vermogen	105 W

Snelheid 7

Capaciteit (IEC 61591)	475 m ³ /h
Geluidsniveau (IEC 60704-2-13)	64 dB(A)
Druk	545 Pa
Vermogen	115 W

Snelheid 8

Capaciteit (IEC 61591)	505 m ³ /h
Geluidsniveau (IEC 60704-2-13)	65 dB(A)
Druk	550 Pa
Vermogen	130 W

Snelheid Intensief

Capaciteit (IEC 61591)	550 m ³ /h
Geluidsniveau (IEC 60704-2-13)	66 dB(A)
Druk	555 Pa
Vermogen	140 W

Intensieve snelheid 2

Capaciteit (IEC 61591)	700 m ³ /h
Geluidsniveau (IEC 60704-2-13)	72 dB(A)
Druk	560 Pa
Vermogen	220 W

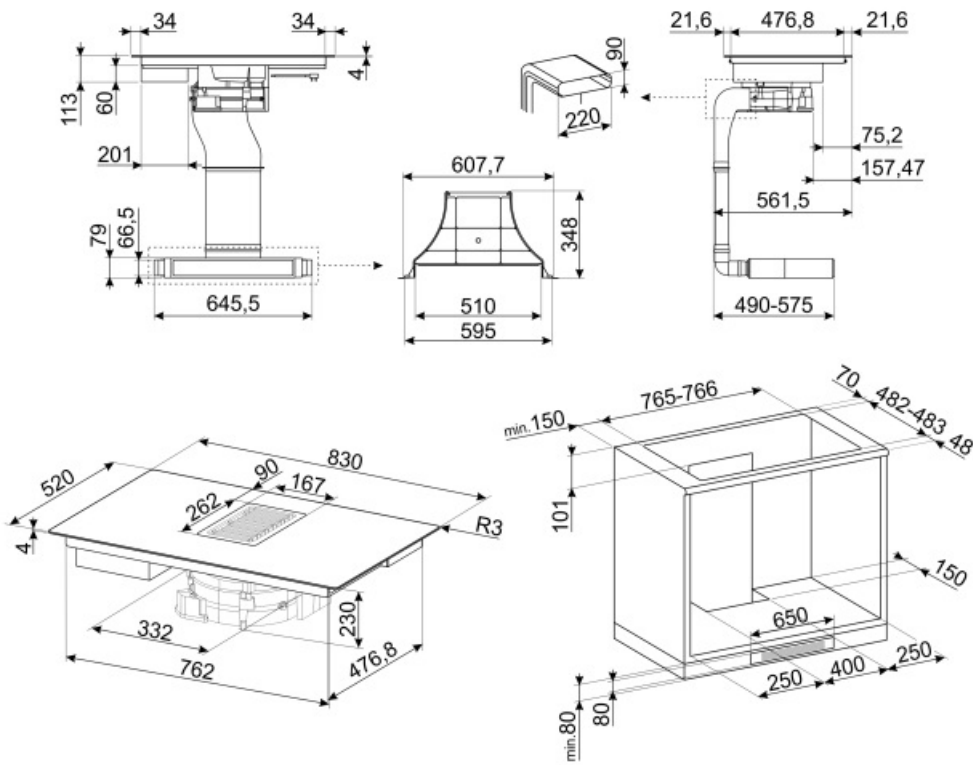

Accessoires niet inbegrepen



KITF6HOBD

Recirculatiekit voor Hobd: buizen + regenererbaar anti-geurfilter + rooster in roestvrij staal met magnetische bevestiging (gemakkelijk te verwijderen) die passen in een sokkel van min. 6 cm

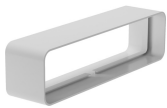

CON60H

Flat duct connector for tubes 220*60 mm. It help to connect more tubes of the kit KITEHOBD4



GRI60H

Rectangular Louvred grille, external size 246*80 mm and internal 226*60*50 mm



KITEHOBD4

Filterkit (zijuitlaat) optioneel voor Hobd: buis 1,5 mt en bocht



FLTHOBD

Keramisch anti-geurfilter regenererbaar als reserveonderdeel geschikt voor recirculatiekit (accessoire KITF6HOBD) voor kookplaat met geïntegreerde afzuiging, modellen HOBD682D en HOBD682R



RED60H

Reducer from 90 to 60 mm



TPK

















Roestvrijstalen grillplaat om Teppanyaki-gerechten te bereiden



FLTHOBD4

Charcoal Anti Odour Filter regenerable as spare part suitable for HOBD482D

Symbols glossary (TT)

 <p>Powerbooster: optie zorgt ervoor dat de zone op vol vermogen werkt wanneer zeer intensief koken nodig is.</p>	 <p>Heavy duty gietijzeren pannendragers: voor maximale stabiliteit en sterkte.</p>
 <p>Kinderslot: sommige modellen zijn voorzien van een apparaat om het programma / de cyclus te vergrendelen zodat het niet kan per ongeluk veranderd</p>	 <p>The slider control panel allows you to adjust the power simply by passing your finger across the touch device.</p>
 <p>This function allows you to keep cooked food warm without burner it</p>	 <p>Multizone: allows several pans to be used at once, large or small, offering freedom of placement and greater flexibility</p>
 <p>Overfill protection: The special overfill protection shuts down the stove in the presence of overflow of liquids.</p>	 <p>All cooking zones can be reduced to the minimum power level, so the hob can be left unattended for a short period without food overcooking or burning. Then just press again this function, the previously set power levels can be reactivated.</p>
 <p>Quick selection, with one touch cooking begins at the highest level, then automatically reduces after time. Ideal for dishes that require quick boiling and then continued cooking without constant control (eg beef broth).</p>	 <p>Quick Start function: the chosen temperature is reached faster. The heating element works at maximum power until the right temperature is reached.</p>
 <p>Indication of residual heat: After the glass ceramic hob is switched off the residual heat indicator shows which of the heating zones still remains hot. When the temperature drops below 60 ° C, the indicator goes out.</p>	 <p>Time elapsed: shows how long the cooking zone has been in use.</p>
 <p>Timer: All ceramic hobs have a timer which automatically ends cooking after a preset time.</p>	 <p>Permanent auto pot detection</p>
 <p>Connection between hob and hood</p>	 <p>Possibility to set the maximum power absorption of the hob</p>
 <p>Evolution Slider totally Back-lighted ghost effect</p>	