

KSG8P4X



Product familie	Dampkap
Type dampkap	Inbouwdampkap
Type dampkap	Volledig integreerbaar
Extractie	Extractie
Elektronische bediening	Ja
Randafzuiging	Ja
Materiaal	Inox
Type staal	Geborsteld inox
EAN-code	8017709319373
Breedte dampkap	75 cm







Design

Design	Universeel	Afwerking	Geborsteld inox
Kleur	Inox	Logo	Geëtst

Bediening

Bediening	Touch bediening met witte LED	LED kleur	Wit
-----------	-------------------------------	-----------	-----

Programma's / Functies

Aantal snelheden	3
Snelheid Intensief	
Luchtzuiveringsfunctie (24 uur)	
Automatische uitschakeling	
Auto-Vent 2.0	

Technische specificaties



Aantal lampen	2	Aantal filters	2
Type lamp	LED	Vetfilters	Aluminium
Vermogen lamp	2.3 W	Indicator vervangen filter	Ja
Dimmerfunctie	Ja		

Temperatuur licht aanpasbaar	2700° - 4000° °K	Diameter ventilatie outlet	150 mm
Capaciteit P0	730 m³/h	Minimum afstand van gaskookplaat	650 mm
Vermogen motor	230 W	Minimum afstand van elektrische kookplaat	650 mm
		Terugslagklep	Ja

	Capaciteit niveau 1 (IEC 61591) [m³/h]	Geluidsniveau niveau 1 (IEC 60704-2-13) [dB(A)]
Snelheid 1	266	46
Snelheid 2	356	52
Snelheid 3	480	60
Snelheid Intensief	681	67

Prestaties / energielabel

A			
Jaarlijkse energieconsumptie (AEC)	53 KWh/jaar	Akoestische A-gewogen geluidsemissie op maximum snelheid	60 dB(A)
Energie-efficiëntieklasse (EEC)	A	Akoestische A-gewogen geluidsvermogens in de lucht met intensieve snelheid	67 dB(A)
Hydrodynamische efficiëntieklasse (FDE)	29,7	Vermogensverbruik in Off modus (Po)	0,49 W
Hydrodynamische efficiëntieklasse (FDEC)	A	Tijdverhogingsfactor (F)	0,9
Licht Efficiëntie (LE)	38,0 lux/W	Energie-efficiëntie Index	52,5
Licht Efficiëntieklasse (LEC)	A	Gemeten luchtdebiet op het beste efficiëntiepunt (Qbep)	356 m³/h
Vetfilter Efficiëntie (GFE)	73,8 %	Gemeten luchtdruk op het beste efficiëntiepunt (Pbep)	448 Pa
Vetfilter Efficiëntieklasse (GFEC)	D	Gemeten elektrisch vermogen op het beste efficiëntiepunt (Wbep)	149 W
Debiet luchtafvoer op minimum snelheid (Qmin)	266 m³/h	Nominaal energieverbruik van de verlichting (WL)	5 W
Luchtstroom bij maximale snelheid (Qmax)	480 m³/h	Gemiddelde verlichting op het kookoppervlak (Emiddle)	175 lux
Luchtstroom bij intensieve snelheid (Qboost)	681 m³/h	Geluidsniveau bij de hoogste instelling (Lwa)	60 dB(A)
Akoestische geluidsdruk op minimum snelheid (SPEmin)	46 dB(A)		

Elektrische aansluiting

Nominale aansluitwaarde 235 W
Spanning 220-240 V

Frequentie 50-60 Hz
Lengte voedingskabel 1500 mm

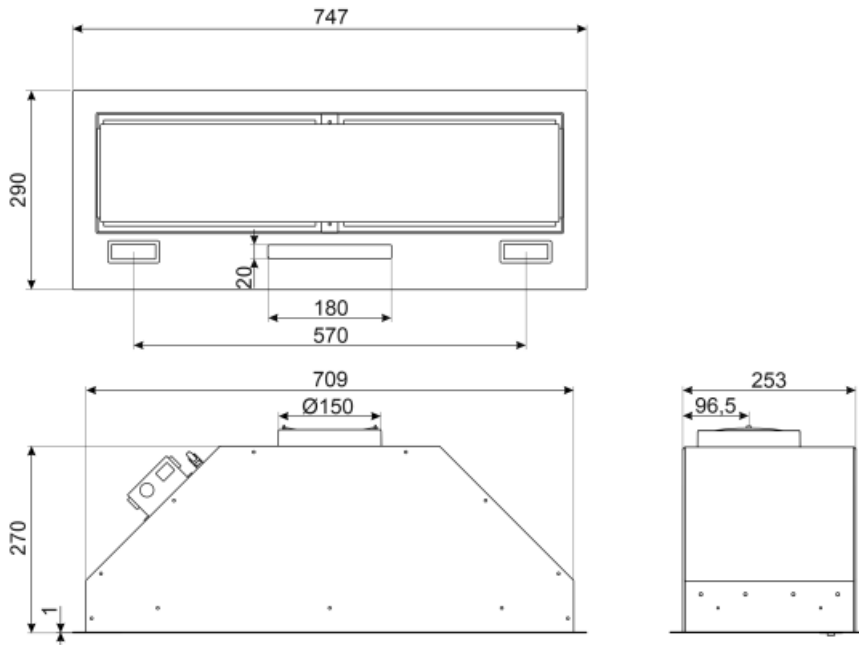

Not included accessories



FLT6











Round Charcoal filters (kit 2 pieces)



KITALLFC

Universal Charcoal filter Stainless Steel AISI 304 The filter can be washed in dishwasher 50 °C (water and suitable detergent) and to dry it put in the oven 180°C 25 minutes

Symbols glossary (TT)

- | | | | |
|---|---|---|---|
|  | 24h: When selected this function refreshes the air for c. 10 minutes every hour over a 24 hour period, at minimum speed and an imperceptible noise level. |  | Filters: Model has filters to help remove grease from the steam emanating from the pans during cooking. |
|  | Connection between hob and hood |  | Automatisch uitschakelen: Een speciale instelling, om na het einde van de bereiding een vooraf ingestelde tijd te laten lopen en daarna automatisch uit te schakelen. |
|  | Dimmering Lights |  | A: Product drying performance, measured from A+++ to D / G depending on the product family |
|  | Warning light(s): to advise when filters need changing. |  | Lights: All cooker hoods feature lights to illuminate the cooking area or add to the ambience of the kitchen. |
|  | Perimeter extraction panels: very efficient and aid noise reduction. |  | Tunable white from warm to cold |
|  | Intensive/turbo setting: when extra fast extraction is required. | | |